

Choose the language

English

Italiano

Français

Deutsch

Pikaia

Four legs/Four legs with armrests

Metal finish:

Polished chrome steel
Lacquered steel (white, red, black and beige)

Body finish:

White polyurethane (PO1)
Red polyurethane (PO2)
Black polyurethane (PO3)
Beige polyurethane (PO4)

→ Reinforced packaging, see page 205.

Chair

Code	Body	Legs	Price in EURO	Packs	Vol. ³	Kg
05PIK02	polyurethane white, beige	lacquered steel		1	0,4	
		polished chrome steel				
05PIK02	polyurethane red, black	lacquered steel		1	0,4	
		polished chrome steel				

2 chairs in each package (Kg. 15) / 1 chair (Kg. 9)

Stackable chair (L max 5 | R max 7)

Code	Body	Legs	Price in EURO	Packs	Vol. ³	Kg
05PIK01	polyurethane white, beige	lacquered steel		1	0,4	
		polished chrome steel				
05PIK01	polyurethane red, black	lacquered steel		1	0,4	
		polished chrome steel				

4 chairs in each package (Kg. 25,5) / 3 (Kg. 20) / 2 (Kg. 15) / 1 chair (Kg. 9)

Optionals

Code		Price in EURO	Packs	Vol. ³	Kg
02AGG05	joining element for stackable versions		1	0,02	1,5
20CAR03	Chair cart (steel with black lacquer)		1	0,12	19

Chairs will be shipped knocked down for orders with more than 8 units.

	Packs	m ³	Kg
 nr. 4	1	0,23	15
 nr. 4	1	0,20	10

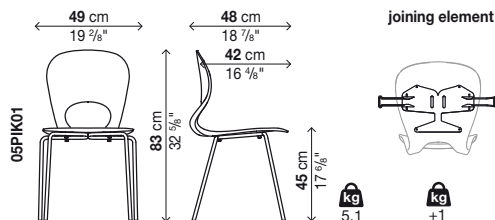
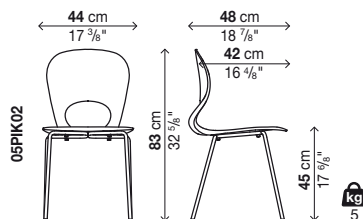

Stackable armchair (L max 5 | R max 7)

Code	Body	Legs	Price in EURO	Packs	Vol. ³	Kg
05PIK03	polyurethane white, beige	lacquered steel		1	0,47	
		polished chrome steel				
05PIK03	polyurethane red, black	lacquered steel		1	0,47	
		polished chrome steel				

4 chairs in each package (Kg. 29) / 3 (Kg. 23) / 2 (Kg. 17) / 1 armchair (Kg. 10,5)

Optionals

Code		Price in EURO	Packs	Vol. ³	Kg
02AGG05	joining element for stackable versions		1	0,02	1,5
02TPK01	writing board in black ABS for armchair version		-	-	2
20CAR03	Chair cart (steel with black lacquer)		1	0,12	19

Chairs will be shipped knocked down for orders with more than 8 units.

	Packs	m ³	Kg
 nr. 4	1	0,23	15
 nr. 4	1	0,4	15

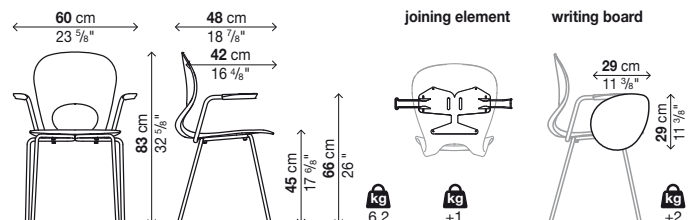

Pikaia

Slide frame/5-spoke base with castors

Metal finish:

Polished chrome steel
Lacquered steel (white, red, black and beige)

Body finish:

White polyurethane (PO1)
Red polyurethane (PO2)
Black polyurethane (PO3)
Beige polyurethane (PO4)

→ Reinforced packaging, see page 205.

Stackable chair (max 5 | max 7)

Code	Body	Legs	Price in EURO	Packs	Vol. ³	Kg
05PIK04	polyurethane white, beige	lacquered steel		1	0,4	
		polished chrome steel				
05PIK04	polyurethane red, black	lacquered steel		1	0,4	
		polished chrome steel				

4 chairs in each package (Kg. 26,4) / 3 (Kg. 20,8) / 2 (Kg. 15,2) / 1 chair (Kg. 9,6)

Optionals

Code		Price in EURO	Packs	Vol. ³	Kg
02AGG05	joining element for stackable versions		1	0,02	1,5
20CAR03	Chair cart (steel with black lacquer)		1	0,12	19

Chair on castors

Code	Body	Legs	Price in EURO	Packs	Vol. ³	Kg
05PIK05	polyurethane white, beige	lacquered steel		1	0,4	11,7
		polished chrome steel				
05PIK05	polyurethane red, black	lacquered steel		1	0,4	11,7
		polished chrome steel				

1 chair in each package

Armchair on castors with armrests



Code	Body	Legs	Price in EURO	Packs	Vol. ³	Kg
05PIK06	polyurethane white, beige	lacquered steel		1	0,4	13,1
		polished chrome steel				
05PIK06	polyurethane red, black	lacquered steel		1	0,4	13,1
		polished chrome steel				

1 armchair in each package

Chairs will be shipped knocked down for orders with more than 8 units.

	Packs	m ³	Kg
 nr. 4	1	0,23	15
 nr. 4	1	0,42	12

Chairs will be shipped knocked down for orders with more than 8 units.

	Packs	m ³	Kg
 nr. 4	1	0,23	15
 nr. 1	1	0,2	7,5
 nr. 1	1	0,2	8,7

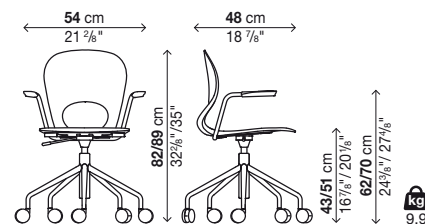
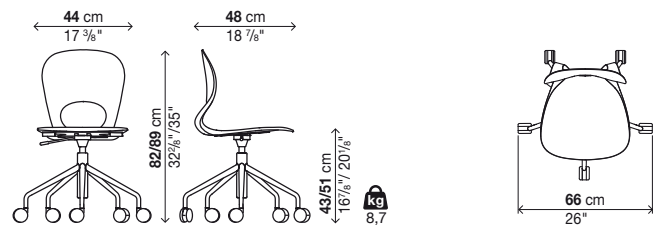
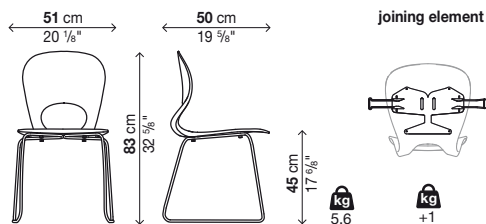

Pikaia

Quattro gambe/Quattro gambe con braccioli

Finitura metallo:

Acciaio cromato

Acciaio verniciato (bianco, rosso, nero, beige)

Finitura scocca:

Poliuretano bianco (PO1)

Poliuretano rosso (PO2)

Poliuretano nero (PO3)

Poliuretano beige (PO4)

→ Imballi rinforzati vedi pag. 205.

Sedia

Codice	Scocca	Gambe	Prezzi EURO	colli: m³: Kg
05PIK02	poliuretano bianco, beige	acciaio verniciato		1 0,4
		acciaio cromato		
05PIK02	poliuretano rosso, nero	acciaio verniciato		1 0,4
		acciaio cromato		

ogni collo contiene 2 sedie (Kg. 15) / 1 sedia (Kg. 9)

Sedia impilabile (L max 5 | max 7)



Codice	Scocca	Gambe	Prezzi EURO	colli: m³: Kg
05PIK01	poliuretano bianco, beige	acciaio verniciato		1 0,4
		acciaio cromato		
05PIK01	poliuretano rosso, nero	acciaio verniciato		1 0,4
		acciaio cromato		

ogni collo contiene 4 sedie (Kg. 25,5) / 3 (Kg. 20) / 2 (Kg. 15) / 1 sedia (Kg. 9)

Optionals

Codice	Prezzi EURO	colli: m³: Kg
02AGG05	elemento di unione per modelli impilabili	1 0,02: 1,5
20CAR03	carrello trasporto sedie (acciaio verniciato nero)	1 0,12: 19

Per ordini superiori alle 8 unità, il prodotto viene spedito smontato.

	colli	m³	Kg
 nr. 4	1	0,23	15
 nr. 4	1	0,20	10

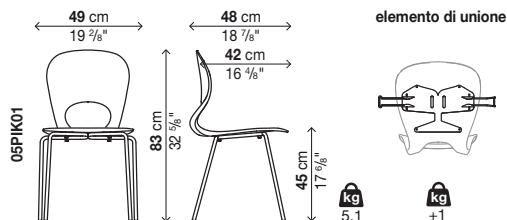
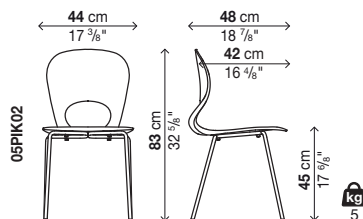

Poltroncina impilabile (L max 5 | max 7)



Codice	Scocca	Gambe	Prezzi EURO	colli: m³: Kg
05PIK03	poliuretano bianco, beige	acciaio verniciato		1 0,47
		acciaio cromato		
05PIK03	poliuretano rosso, nero	acciaio verniciato		1 0,47
		acciaio cromato		

ogni collo contiene 4 poltroncine (Kg. 29) / 3 (Kg. 23) / 2 (Kg. 17) / 1 poltroncina (Kg. 10,5)

Optionals

Codice	Prezzi EURO	colli: m³: Kg
02AGG05	elemento di unione per modelli impilabili	1 0,02: 1,5
02TPK01	tavoletta scrittoio in ABS nero per poltroncina	- - 2
20CAR03	carrello trasporto sedie (acciaio verniciato nero)	1 0,12: 19

Per ordini superiori alle 8 unità, il prodotto viene spedito smontato.

	colli	m³	Kg
 nr. 4	1	0,23	15
 nr. 4	1	0,4	15

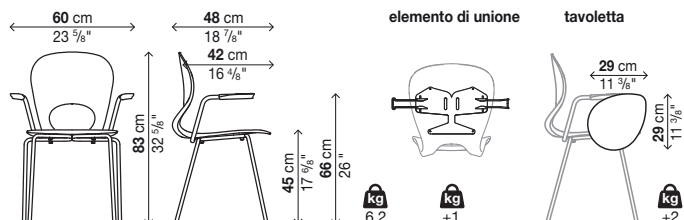

Pikaia

Slitta/Cinque razze con ruote

Finitura metallo:

Acciaio cromato

Acciaio verniciato (bianco, rosso, nero, beige)

Finitura scocca:

Poliuretano bianco (PO1)

Poliuretano rosso (PO2)

Poliuretano nero (PO3)

Poliuretano beige (PO4)

→ Imballi rinforzati vedi pag. 205.

Sedia impilabile (L max 5 | max 7)



Codice	Scocca	Gambe	Prezzi EURO	colli: m³: Kg
05PIK04	poliuretano bianco, beige	acciaio verniciato		1 0,4
		acciaio cromato		
05PIK04	poliuretano rosso, nero	acciaio verniciato		1 0,4
		acciaio cromato		

ogni collo contiene 4 sedie (Kg. 26,4) / 3 (Kg. 20,8) / 2 (Kg. 15,2) / 1 sedia (Kg. 9,6)

Optionals

Codice		Prezzi EURO	colli: m³: Kg
02AGG05	elemento di unione per modelli impilabili		1 0,02 1,5
20CAR03	carrello trasporto sedie (acciaio verniciato nero)		1 0,12 19

Per ordini superiori alle 8 unità, il prodotto viene spedito smontato.

	colli	m³	Kg
 nr. 4	1	0,23	15
 nr. 4	1	0,42	12

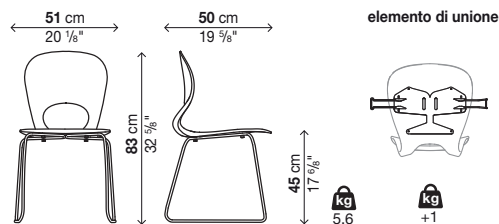

Sedia su ruote

Codice	Scocca	Gambe	Prezzi EURO	colli: m³: Kg
05PIK05	poliuretano bianco, beige	acciaio verniciato		1 0,4 11,7
		acciaio cromato		
05PIK05	poliuretano rosso, nero	acciaio verniciato		1 0,4 11,7
		acciaio cromato		



ogni collo contiene 1 sedia

Poltroncina con braccioli su ruote

Codice	Scocca	Gambe	Prezzi EURO	colli: m³: Kg
05PIK06	poliuretano bianco, beige	acciaio verniciato		1 0,4 13,1
		acciaio cromato		
05PIK06	poliuretano rosso, nero	acciaio verniciato		1 0,4 13,1
		acciaio cromato		

ogni collo contiene 1 poltroncina

Per ordini superiori alle 8 unità, il prodotto viene spedito smontato.

	colli	m³	Kg
 nr. 4	1	0,23	15
 nr. 1	1	0,2	7,5
 nr. 1	1	0,2	8,7

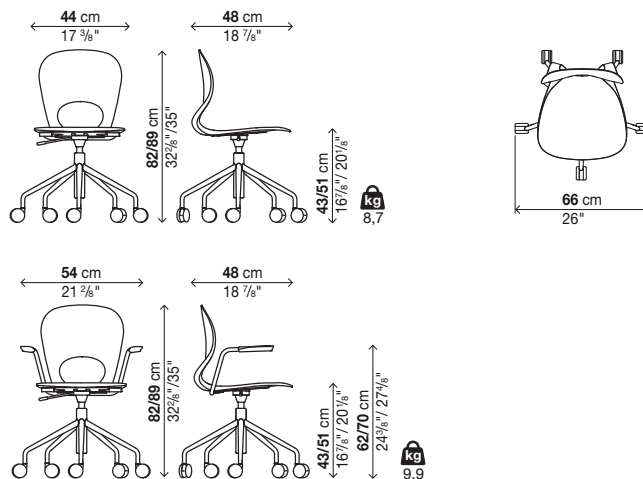

Pikaia

Quatre pieds/Quatre pieds avec accoudoirs

Finition du métal:

Acier chromé

Acier laqué (blanc, rouge, noir, beige)

Finition coque:

Polyuréthane blanc (PO1)

Polyuréthane rouge (PO2)

Polyuréthane noir (PO3)

Polyuréthane beige (PO4)

→ Emballages renforcés voir page 205.

Chaise

Code	Coque	Pieds	Prix en EURO	Colis	m ³	Kg
05PIK02	polyuréthane blanc, beige	acier laqué		1	0,4	
		acier chromé				
05PIK02	polyuréthane rouge, noir	acier laqué		1	0,4	
		acier chromé				

chaque colis 2 chaises (Kg. 15) / 1 chaise (Kg. 9)

Chaise empilable (L max 5 | H max 7)

Code	Coque	Pieds	Prix en EURO	Colis	m ³	Kg
05PIK01	polyuréthane blanc, beige	acier laqué		1	0,4	
		acier chromé				
05PIK01	polyuréthane rouge, noir	acier laqué		1	0,4	
		acier chromé				

chaque colis 4 chaises (Kg. 25,5) / 3 (Kg. 20) / 2 (Kg. 15) / 1 chaise (Kg. 9)

Optionals

Code	Prix en EURO	Colis	m ³	Kg
02AGG05	élément de jonction pour modèles empilables	1	0,02	1,5
20CAR03	Chariot pour transport chaises (acier laqué noir)	1	0,12	19

Pour des commandes de plus de 8 articles, les chaises seront livrées démontées.

	Colis	m ³	Kg
 n° 4	1	0,23	15
 n° 4	1	0,20	10

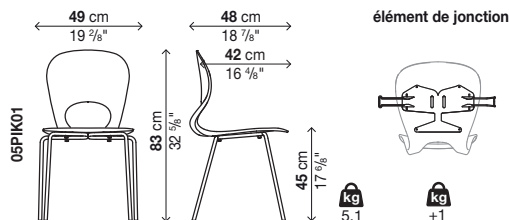
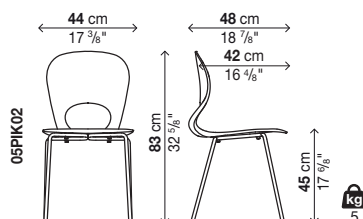

Fauteuil empilable (L max 5 | H max 7)

Code	Coque	Pieds	Prix en EURO	Colis	m ³	Kg
05PIK03	polyuréthane blanc, beige	acier laqué		1	0,47	
		acier chromé				
05PIK03	polyuréthane rouge, noir	acier laqué		1	0,47	
		acier chromé				

chaque colis 4 fauteuils (Kg. 29) / 3 (Kg. 23) / 2 (Kg. 17) / 1 fauteuil (Kg. 10,5)

Optionals

Code	Prix en EURO	Colis	m ³	Kg
02AGG05	élément de jonction pour modèles empilables	1	0,02	1,5
02TPK01	tablette écrivain en ABS noir pour fauteuil	-	-	2
20CAR03	Chariot pour transport chaises (acier laqué noir)	1	0,12	19

Pour des commandes de plus de 8 articles, les chaises seront livrées démontées.

	Colis	m ³	Kg
 n° 4	1	0,23	15
 n° 4	1	0,4	15

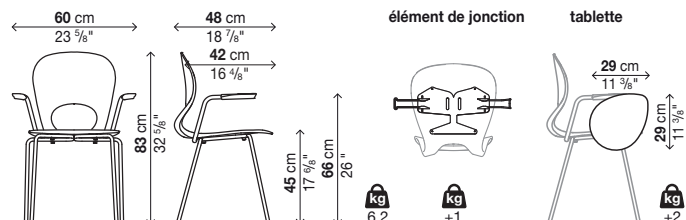

Pikaia

Luge/Cinq branches avec roulettes

Finition du métal:

Acier chromé
Acier laqué (blanc, rouge, noir, beige)

Finition coque:

Polyuréthane blanc (PO1)
Polyuréthane rouge (PO2)
Polyuréthane noir (PO3)
Polyuréthane beige (PO4)

→ Emballages renforcés voir page 205.

Chaise empilable (max 5 | max 7)

Code	Coque	Pieds	Prix en EURO	Colis	m ³	Kg
05PIK04	polyuréthane blanc, beige	acier laqué		1	0,4	
		acier chromé				
05PIK04	polyuréthane rouge, noir	acier laqué		1	0,4	
		acier chromé				

chaque colis 4 chaises (Kg. 26,4) / 3 (Kg. 20,8) / 2 (Kg. 15,2) / 1 chaise (Kg. 9,6)

Optionals

Code		Prix en EURO	Colis	m ³	Kg
02AGG05	élément de jonction pour modèles empilables		1	0,02	1,5
20CAR03	Chariot pour transport chaises (acier laqué noir)		1	0,12	19

Chaise à roulettes

Code	Coque	Pieds	Prix en EURO	Colis	m ³	Kg
05PIK05	polyuréthane blanc, beige	acier laqué		1	0,4	11,7
		acier chromé				
05PIK05	polyuréthane rouge, noir	acier laqué		1	0,4	11,7
		acier chromé				



chaque colis 1 chaise

Fauteuil à roulettes avec accoudoirs



Code	Coque	Pieds	Prix en EURO	Colis	m ³	Kg
05PIK06	polyuréthane blanc, beige	acier laqué		1	0,4	13,1
		acier chromé				
05PIK06	polyuréthane rouge, noir	acier laqué		1	0,4	13,1
		acier chromé				

chaque colis 1 fauteuil

Pour des commandes de plus de 8 articles, les chaises seront livrées démontées.

	Colis	m ³	Kg
 n° 4	1	0,23	15
 n° 4	1	0,42	12

Pour des commandes de plus de 8 articles, les chaises seront livrées démontées.

	Colis	m ³	Kg
 n° 4	1	0,23	15
 n° 1	1	0,2	7,5
 n° 1	1	0,2	8,7

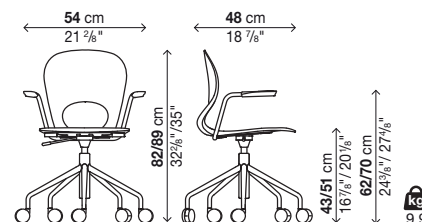
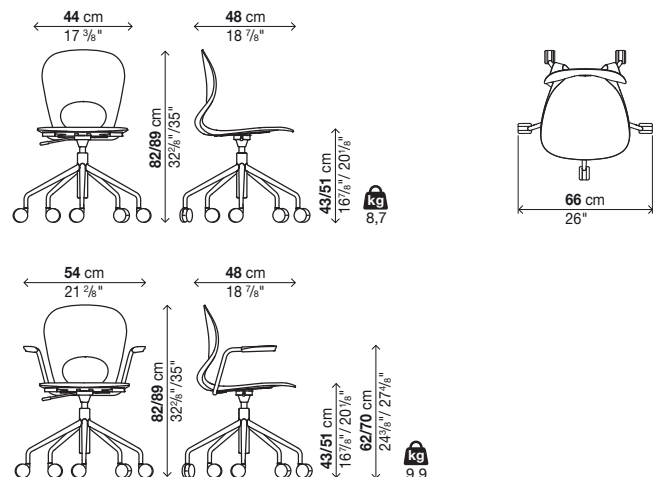
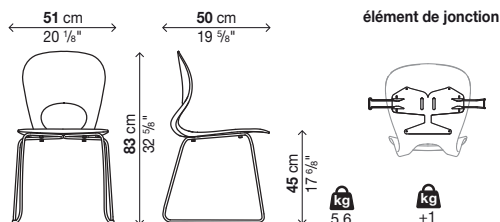

Pikaia

Vier Beine/Vier Beine mit Armlehnen

Metallausführung:

Verchromter Stahl
Lackierter Stahl (Weiß, Rot, Schwarz, Beige)

Ausführung Aufbau:

Polyurethan in Weiß (PO1)
Polyurethan in Rot (PO2)
Polyurethan in Schwarz (PO3)
Polyurethan in Beige (PO4)

→ Verstärkte Verpackungsmaterialien siehe Seite 205.

Stuhl

Art.-Nr.	Rahmen	Beine	Preis in EURO	Kolli V. m ³ Kg
05PIK02	Polyurethan Weiß, Beige	Lackierter Stahl		1 0,4
		Verchromter Stahl		
05PIK02	Polyurethan Rot, Schwarz	Lackierter Stahl		1 0,4
		Verchromter Stahl		

jedes Frachtstück beinhaltet 2 Stühle (Kg. 15) / 1 Stuhl (Kg. 9)

Stapelbarer Stuhl (L max 5 | R max 7)



Art.-Nr.	Rahmen	Beine	Preis in EURO	Kolli V. m ³ Kg
05PIK01	Polyurethan Weiß, Beige	Lackierter Stahl		1 0,4
		Verchromter Stahl		
05PIK01	Polyurethan Rot, Schwarz	Lackierter Stahl		1 0,4
		Verchromter Stahl		

jedes Frachtstück beinhaltet 4 Stühle (Kg. 25,5) / 3 (Kg. 20) / 2 (Kg. 15) / 1 Stuhl (Kg. 9)

Optionals

Art.-Nr.		Preis in EURO	Kolli V. m ³ Kg
02AGG05	Verbindungselement für stapelbare Modelle		1 0,02 1,5
20CAR03	Stuhlkarre (Stahl lackiert in schwarz)		1 0,12 19

Bei Bestellungen mit mehr als 8 Produkte, werden diese zerlegt geliefert - Sitz und Untergestell getrennt

	Kolli	m ³	Kg
 Nr. 4	1	0,23	15
 Nr. 4	1	0,20	10

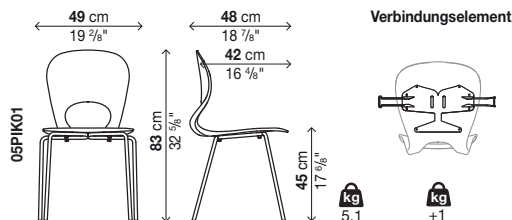
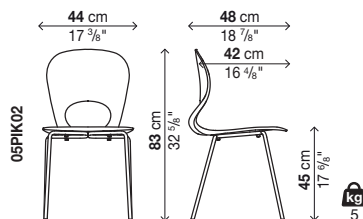

Stapelbarer Sessel (L max 5 | R max 7)



Art.-Nr.	Rahmen	Beine	Preis in EURO	Kolli V. m ³ Kg
05PIK03	Polyurethan Weiß, Beige	Lackierter Stahl		1 0,47
		Verchromter Stahl		
05PIK03	Polyurethan Rot, Schwarz	Lackierter Stahl		1 0,47
		Verchromter Stahl		

4 Stühle pro Frachtstück (Kg. 29) / 3 (Kg. 23) / 2 (Kg. 17) / 1 Stuhl (Kg. 10,5)

Optionals

Art.-Nr.		Preis in EURO	Kolli V. m ³ Kg
02AGG05	Verbindungselement für stapelbare Modelle		1 0,02 1,5
02TPK01	Schreibplatte aus schwarzem ABS für Sessel		- - 2
20CAR03	Stuhlkarre (Stahl lackiert in schwarz)		1 0,12 19

Bei Bestellungen mit mehr als 8 Produkte, werden diese zerlegt geliefert - Sitz und Untergestell getrennt

	Kolli	m ³	Kg
 Nr. 4	1	0,23	15
 Nr. 4	1	0,4	15

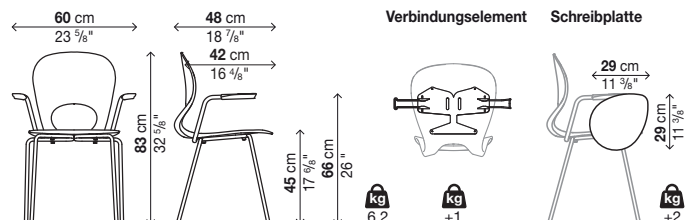

Pikaia

Kufengestell/Fünf Ausleger mit Rollen

Metallausführung:

Verchromter Stahl
Lackierter Stahl (Weiß, Rot, Schwarz, Beige)

Ausführung Aufbau:

Polyurethan in Weiß (PO1)
Polyurethan in Rot (PO2)
Polyurethan in Schwarz (PO3)
Polyurethan in Beige (PO4)

→ Verstärkte Verpackungsmaterialien siehe Seite 205.

Stapelbarer Stuhl (max 5 | max 7)



Art.-Nr.	Rahmen	Beine	Preis in EURO	Kolli V. m³ Kg
05PIK04	Polyurethan Weiß, Beige	Lackierter Stahl		1 0,4
		Verchromter Stahl		
05PIK04	Polyurethan Rot, Schwarz	Lackierter Stahl		1 0,4
		Verchromter Stahl		

jedes Frachtstück beinhaltet 4 Stühle (Kg. 26,4) / 3 (Kg. 20,8) / 2 (Kg. 15,2) / 1 Stuhl (Kg. 9,6)

Optionals

Art.-Nr.	Preis in EURO	Kolli V. m³ Kg
02AGG05	Verbindungselement für stapelbare Modelle	1 0,02 1,5
20CAR03	Stuhlkarre (Stahl lackiert in schwarz)	1 0,12 19

Bei Bestellungen mit mehr als 8 Produkte, werden diese zerlegt geliefert - Sitz und Untergestell getrennt

	Kolli	m³	Kg
 Nr. 4	1	0,23	15
 Nr. 4	1	0,42	12

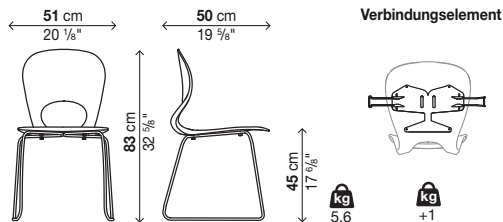

Stuhl auf Rollen

Art.-Nr.	Rahmen	Beine	Preis in EURO	Kolli V. m³ Kg
05PIK05	Polyurethan Weiß, Beige	Lackierter Stahl		1 0,4 11,7
		Verchromter Stahl		
05PIK05	Polyurethan Rot, Schwarz	Lackierter Stahl		1 0,4 11,7
		Verchromter Stahl		



Ein Stuhl pro Frachtstück

Sessel mit Armlehnen auf Rollen

Art.-Nr.	Rahmen	Beine	Preis in EURO	Kolli V. m³ Kg
05PIK06	Polyurethan Weiß, Beige	Lackierter Stahl		1 0,4 13,1
		Verchromter Stahl		
05PIK06	Polyurethan Rot, Schwarz	Lackierter Stahl		1 0,4 13,1
		Verchromter Stahl		

Ein Stuhl pro Frachtstück

Bei Bestellungen mit mehr als 8 Produkte, werden diese zerlegt geliefert - Sitz und Untergestell getrennt

	Kolli	m³	Kg
 Nr. 4	1	0,23	15
 Nr. 1	1	0,2	7,5
 Nr. 1	1	0,2	8,7

