Info components



Elegant and versatile couches by Quinti Sedute. Loft 2,0 combines modern design with outstanding features, and can be upholstered with all the materials and finishes of Quinti Colours System.

High quality materials that ensure comfort and are made to withstand the test of time.

All Quinti products are covered by a 5 year warranty and are 100% Made in Italy. Certification n. 290.058v

Modularity

- 551. Two seater with sides
- 552. Two seater without sides
- 554 Two seater with right side only
- 555 Two seater with left side only
- 553. 2 seater bench

HI BACK & LOW BACK

Lateral and back pannels are realized in wood instead of the seat realized in painted metal, with elastic belts, padded with foam.

LOFT can be upholstered in all QCS colours, with horizontal stitching and back cushion. Granted comfort of intrinsic soundproof (HI BACK).

It can be disassembled (disassembling kit included).

Legs









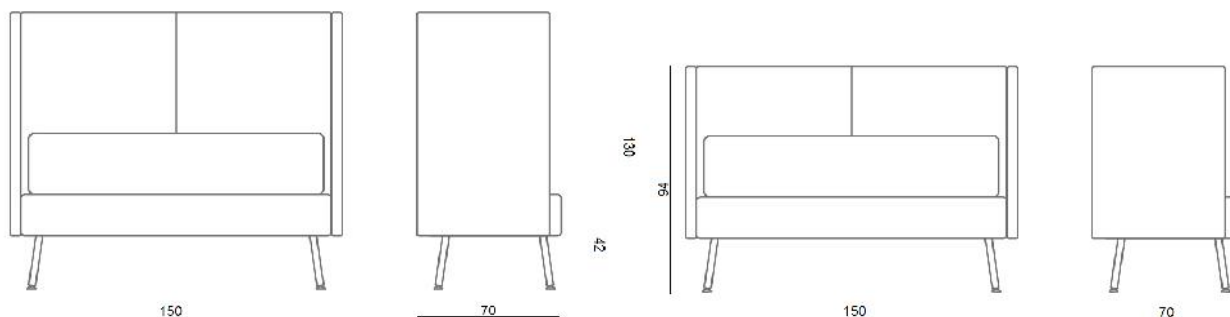





Loft is available in a unique version, with 4 adjustable feet (chromed or white painted).

Accessories

The range is completed with a bench that can be also used as table. JOLLY tables and pouf complete the range.

Dimensions & range



*MATERIAL		CAT	Availability	
CREPE		1		
ECOPELLE / LEATHERETTE		2	•	
XTREME		2		
BIKO		2	•	
LASER		2	•	
SISTEMA PRO		3	•	
TRAMA		3	•	
MELANGE		3	•	
JET		3	•	
LANA / WOOL		5	•	
PELLE / LEATHER		5	•	
PELLE NERA / LEATHER BLACK		5S	•	
TEMPO Kvadrat		6	•	
PELLE / LEATHER ELEGANCE PREMIUM		7	•	
PELLE / LEATHER SOFT		7	•	
STILKAT TRIO Kvadrat		7	•	
TESSUTO CLIENTE H.140 cm		1		

SHIPPING SPECS	TECHNICAL SPECS	IGNIFUGUE TEST	RESISTANCE TEST
<ul style="list-style-type: none"> • Bundle 2 • m³ 1,60 • Kg. 45 	Fabric consumption MTL 7,80 x h.140	For further specifications, please check fabrics in the colours system. For further information, please contact us.	For further specifications, please check fabrics in the colours system. For further information, please contact us.

Usage & care

In order to maintain Quinti products in perfect conditions through time and obtain a long lasting quality of the raw materials we hereby recommend to follow some very basic care instructions.

FABRICS

- Cleaning: see the dedicated selection written on the color Swatch card.
- Usage: we recommend a particular care as fabrics can be easily cut or ripped.

LEATHER

- Cleaning: Clean with a soft cloth with water. We remind that leather is extremely delicate. We recommend to use high quality products and to follow the instructions of the manufacturer. In case of doubts, we recommend to test the product on a hidden part and to wait at least 24 hours should any problem arise.
- Usage: It is very important to look carefully at the wash suggested and to pay particular attention while using.

PLASTIC MATERIALS

- Cleaning: plastic surfaces usually need to be cleaned with a cloth and water. We recommend not to use dry cloths that might generate an electrostatic charge that will capture dust. For the most persistent stains a small amount of liquid soap diluted in water may be used.

WOOD

- Cleaning: plywood surfaces need to be cleaned with a cloth and water. We recommend to dry immediately after the cleaning process. All liquids or other residue must be removed in order to avoid the absorption of the same.
- Usage: being plywood a natural material you might notice an alteration of the color shade during time and use. We also remind that plywood cannot bear with warm surfaces or high temperatures if placed directly on the wooden top.

METALS

- Cleaning: plastic surfaces usually need to be cleaned with a cloth and water. For the most persistent stains a small amount of liquid soap diluted in water may be used. We always recommend to try immediately after the cleaning process by using a soft cloth or a leather one. Never use cleaning products for steel, chlorine, bleach or other strong detergents. Avoid abrasive creams, score pads and abrasive sponges that can scratch the metal surfaces.
- Usage: mind the stains of food such as coffee, juices, coke, if not removed immediately they might leave indelible marks on the surface.

WARRANTY

all the products are covered by a 5 years warranty. For the first 24 months: free repair of any flaw due to the production processes; from 24 to 60 months: working hours and carriage costs will be charged to the client. The warranty for the mechanisms is 12 months.

The warranty is not valid if:

- Damages and deterioration are due to the normal wear and tear.
- Damages and deterioration are due to an incorrect use.
- Deterioration caused by an inappropriate care of the materials.
- In case of use for more than 8 hours the warranty is valid only for 24 months.

Quinti Sedute Srl

Zona ind.le Parco il Granaio
52046 Cesa della Chiana, Arezzo [Italy]
T. +39 0575 66970
F.+39 0575 66936
I. info@quinti.com
www.quinti.com

Quinti si riserva di apportare modifiche e/o migliorie di carattere tecnico ed estetico ai propri modelli e prodotti in qualsiasi momento e senza preavviso.
Per maggiori informazioni visitate il sito www.quinti.com
Quinti reserves the right to make modifications and improvements of technical or aesthetic nature to the products at any time without notice.
For further information, please visit www.quinti.com